

Low profile centrifugal roof-fans, horizontal discharge, composed of:

- Centrifugal backward curved impeller.
- Steel finger proof guard.
- Base manufactured from galvanised sheet steel and aluminium cowl.
- ON-OFF electrical isolation switch.
- Direct supply brushless EC motor, high performance, low consumption, ball bearings, built-in thermal protector and able to work at temperatures from -20°C to +40°C:
- Single-phase version 230V±10% 50/60Hz, IP44.
- Three-phase version 400V±10% 50/60Hz, IP54.

Fan speed adjustable with the potentiometer placed in the connection box or with an external control type REB ECOWATT.

Analogical input with terminals in the terminal box to control the fan with 0-10V input signal.



Low profile
 External rotor motor to limit the height of the fan.



Direct drive backward
 Centrifugal impeller with brushless EC motor.



Bird proof guard



ON-OFF electrical isolated switch



Low profile centrifugal roof-fans, vertical discharge, composed of:

- Centrifugal backward curved impeller.
- Steel finger proof guard.
- Base manufactured from galvanised sheet steel and aluminium cowl.
- ON-OFF electrical isolation switch.
- Direct supply brushless EC motor, high performance, low consumption, ball bearings, built-in thermal protector and able to work at temperatures from -20°C to +40°C:

Single-phase version 230V±10%
50/60Hz, IP44.

Three-phase version 400V±10%
50/60Hz, IP54.

Fan speed adjustable with the potentiometer placed in the connection box or with an external control type REB ECOWATT.

Analogical input with terminals in the terminal box to control the fan with 0-10V input signal.



Direct drive backward
Centrifugal impeller with
brushless EC motor.



Bird proof guard



**ON-OFF electrical isolated
switch**

LOW CONSUMPTION ROOF MOUNTED FANS

CRHB-N / CRHT-N / CRVB-N / CRVT-N ECOWATT Series



TECHNICAL CHARACTERISTICS

Before installation check that the product electrical characteristics listed on the data plate label (Voltage, power, frequency, etc.) match those of the intended electrical supply.

Model	Input tension regul. (V)	Speed (r.p.m.)	Maximum absorbed power (W)	Maximum absorbed current (A)	Maximum airflow (m ³ /h)	Sound pressure level* at 4m (dB(A))		Weight (kg)
						Inlet	Outlet	
SINGLE-PHASE HORIZONTAL DISCHARGE MODELS								
CRHB-250 N ECOWATT	10	2640	216	1,4	1.380	47	53	10
	8	2280	140	1,0	1.190	44	49	
	6	1770	70	0,5	920	38	44	
	4	1270	30	0,2	670	31	37	
CRHB-280 N ECOWATT	10	1800	180	0,8	2.026	44	51	16
	8	1592	131	0,6	1.593	42	49	
	6	1288	75	0,4	1.439	37	44	
	4	979	39	0,2	1.093	31	38	
CRHB-315 N ECOWATT	10	1700	276	0,8	2.812	49	52	18
	8	1493	200	0,6	2.498	47	50	
	6	1295	127	0,3	2.204	44	48	
	4	1091	78	0,3	1.826	39	43	
CRHB-355 N ECOWATT	10	1499	338	1,4	3.456	46	54	22
	8	1332	238	1,0	3.082	43	51	
	6	1098	143	0,6	2.644	39	47	
	4	859	73	0,3	2.024	34	42	
CRHB-400 N ECOWATT	10	1770	917	3,8	5.730	55	62	32
	8	1580	664	2,8	4.990	53	60	
	6	1250	345	1,5	3.990	48	54	
	4	950	167	0,7	2.960	42	48	
CRHB-450 N ECOWATT	10	1400	861	3,6	6.280	53	60	35
	8	1230	594	2,5	5.520	50	57	
	6	1020	340	1,4	4.540	46	53	
	4	820	188	0,8	3.650	41	48	
THREE-PHASE HORIZONTAL DISCHARGE MODELS								
CRHT-450 N ECOWATT	10	1600	1267	2,1	7.100	56	65	35
	8	1400	847	1,4	6.270	53	62	
	6	1140	481	0,9	5.080	48	58	
	4	890	243	0,5	3.940	43	52	
CRHT-500 N ECOWATT	10	1270	1145	1,8	7.970	53	60	40
	8	1130	810	1,4	7.100	50	57	
		950	481	0,9	5.980	46	54	
	4	770	271	0,6	4.870	42	49	

*Sound pressure level measured at 4m, roof fan installed on a plan, at the 2, 5, 8 and 11 working points of the performance curve.

LOW CONSUMPTION ROOF MOUNTED FANS

CRHB-N / CRHT-N / CRVB-N / CRVT-N ECOWATT Series



TECHNICAL CHARACTERISTICS

Before installation check that the product electrical characteristics listed on the data plate label (Voltage, power, frequency, etc.) match those of the intended electrical supply.

Model	Input tension regul. (V)	Speed (r.p.m.)	Maximum absorbed power (W)	Maximum absorbed current (A)	Maximum airflow (m³/h)	Sound pressure level* at 4m (dB(A))		Weight (kg)
						Inlet	Outlet	
SINGLE-PHASE VERTICAL DISCHARGE MODELS								
CRVB-250 N ECOWATT	10	2640	216	1,4	1.320	47	51	11
	8	2280	142	1,0	1.150	44	48	
	6	1770	71	0,5	890	38	43	
	4	1260	31	0,3	640	31	35	
CRVB-280 N ECOWATT	10	1799	183	0,8	1.823	46	55	18
	8	1576	129	0,6	1.593	43	52	
	6	1273	74	0,4	1.283	38	47	
	4	967	30	0,3	988	32	41	
CRVB-315 N ECOWATT	10	1700	270	0,8	2.703	51	58	20
	8	1468	183	0,6	2.411	47	55	
	6	1276	124	0,3	2.087	43	50	
	4	1078	81	0,2	1.756	38	44	
CRVB-355 N ECOWATT	10	1499	348	1,5	3.388	43	49	25
	8	1332	242	1,0	3.016	40	46	
	6	1105	143	0,6	2.530	36	43	
	4	862	74	0,4	2.051	31	37	
CRVB-400 N ECOWATT	10	1770	953	3,9	5.560	55	58	34
	8	1560	646	2,7	4.920	52	55	
	6	1270	366	1,5	3.980	48	51	
	4	960	173	0,8	2.900	41	45	
CRVB-450 N ECOWATT	10	1400	839	3,5	6.050	47	59	37
	8	1260	654	2,7	5.460	45	57	
	6	1030	362	1,5	4.440	40	52	
	4	820	196	0,8	3.540	35	47	
THREE-PHASE VERTICAL DISCHARGE MODELS								
CRVT-450 N ECOWATT	10	1570	1228	2,0	6.690	56	61	37
	8	1420	849	1,4	6.000	53	58	
	6	1160	496	0,9	4.880	48	54	
	4	890	244	0,5	3.720	43	48	
CRVT-500 N ECOWATT	10	1270	1156	1,9	7.660	52	58	44
	8	1140	818	1,5	6.900	50	56	
	6	960	488	0,9	5.770	46	52	
	4	770	267	0,6	4.730	42	47	

*Sound pressure level measured at 4m, roof fan installed on a plan, at the 2, 5, 8 and 11 working points of the performance curve.

PERFORMANCE CURVES - ACOUSTIC CHARACTERISTICS

- q_v : Airflow in m^3/h .
- p_{sf} : Static pressure in Pa.
- P: Input power in W.
- SFP: Specific fan power in $W/m^3/s$ (blue curves).
- Performance data in accordance with ISO 5801 and AMCA 210-99 Standards.

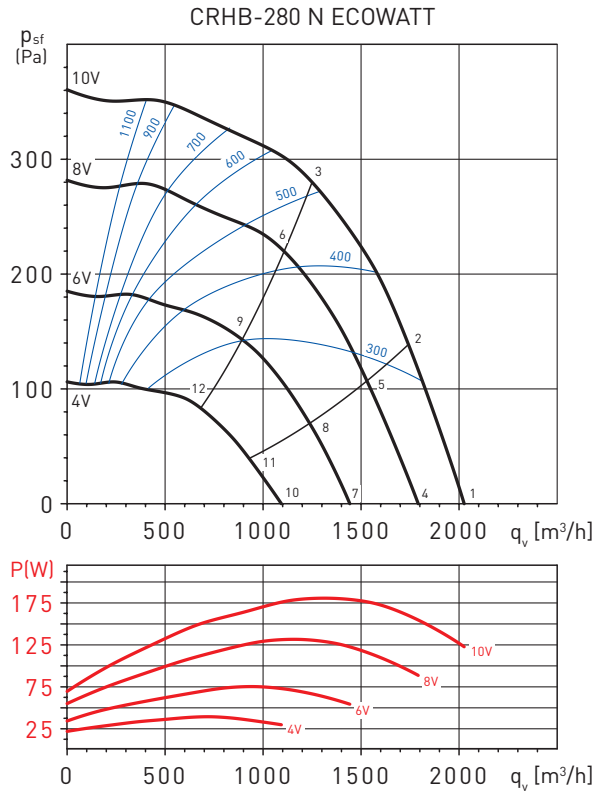
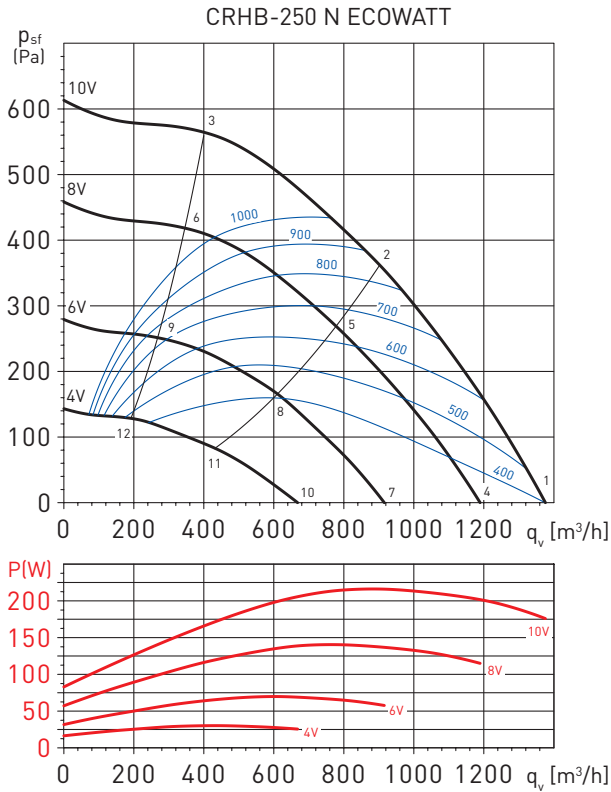

Working point		63	125	250	500	1.000	2.000	4.000	8.000	LwA
1	Inlet	37,0	52,0	66,0	68,0	68,0	68,0	70,0	64,0	75,0
	Outlet	39,0	52,0	71,0	70,0	75,0	76,0	74,0	69,0	81,0
2	Inlet	37,0	47,0	62,0	62,0	63,0	64,0	62,0	57,0	70,0
	Outlet	37,0	48,0	64,0	64,0	70,0	71,0	68,0	62,0	76,0
3	Inlet	38,0	49,0	62,0	64,0	64,0	66,0	64,0	58,0	72,0
	Outlet	38,0	49,0	63,0	65,0	72,0	75,0	71,0	65,0	78,0
4	Inlet	34,0	49,0	63,0	64,0	65,0	65,0	67,0	60,0	72,0
	Outlet	35,0	49,0	67,0	67,0	72,0	72,0	71,0	66,0	78,0
5	Inlet	34,0	43,0	59,0	59,0	60,0	60,0	59,0	54,0	67,0
	Outlet	34,0	45,0	61,0	61,0	67,0	68,0	64,0	59,0	72,0
6	Inlet	35,0	46,0	58,0	61,0	61,0	63,0	61,0	55,0	68,0
	Outlet	35,0	46,0	60,0	62,0	69,0	71,0	68,0	62,0	75,0
7	Inlet	29,0	43,0	57,0	59,0	59,0	59,0	61,0	55,0	67,0
	Outlet	30,0	43,0	62,0	61,0	67,0	67,0	65,0	60,0	72,0
8	Inlet	28,0	38,0	54,0	53,0	54,0	55,0	54,0	49,0	61,0
	Outlet	29,0	39,0	55,0	55,0	62,0	63,0	59,0	53,0	67,0
9	Inlet	29,0	40,0	53,0	55,0	56,0	58,0	55,0	49,0	63,0
	Outlet	29,0	40,0	54,0	57,0	64,0	66,0	62,0	56,0	70,0
10	Inlet	21,0	36,0	50,0	52,0	52,0	52,0	54,0	48,0	60,0
	Outlet	23,0	36,0	55,0	54,0	60,0	60,0	58,0	53,0	65,0
11	Inlet	21,0	31,0	46,0	46,0	47,0	48,0	47,0	41,0	54,0
	Outlet	21,0	32,0	48,0	48,0	54,0	56,0	52,0	46,0	60,0
12	Inlet	22,0	33,0	46,0	48,0	49,0	51,0	48,0	42,0	56,0
	Outlet	22,0	33,0	47,0	49,0	56,0	59,0	55,0	49,0	62,0

Working point		63	125	250	500	1.000	2.000	4.000	8.000	LwA
1	Inlet	37,0	51,0	59,0	64,0	62,0	62,0	63,0	53,0	69,4
	Outlet	38,0	53,0	64,0	68,0	72,0	70,0	68,0	58,0	76,2
2	Inlet	35,0	46,0	56,0	61,0	61,0	61,0	60,0	51,0	67,3
	Outlet	35,0	47,0	62,0	66,0	71,0	68,0	65,0	55,0	74,5
3	Inlet	33,0	43,0	55,0	61,0	61,0	61,0	58,0	49,0	66,8
	Outlet	33,0	45,0	59,0	64,0	71,0	68,0	63,0	54,0	73,9
4	Inlet	34,3	48,3	56,3	61,3	59,3	59,3	60,3	50,3	66,8
	Outlet	35,3	50,3	61,3	65,3	69,3	67,3	65,3	55,3	73,5
5	Inlet	32,3	43,3	53,3	58,3	58,3	58,3	57,3	48,3	64,6
	Outlet	32,3	44,3	59,3	63,3	68,3	65,3	62,3	52,3	71,8
6	Inlet	30,3	40,3	52,3	58,3	58,3	58,3	55,3	46,3	64,2
	Outlet	30,3	42,3	56,3	61,3	68,3	65,3	60,3	51,3	71,2
7	Inlet	27,1	41,1	49,1	54,1	52,1	52,1	53,1	43,1	59,5
	Outlet	30,7	45,7	56,7	60,7	64,7	62,7	60,7	50,7	68,9
8	Inlet	27,7	38,7	48,7	53,7	53,7	53,7	52,7	43,7	60,0
	Outlet	27,7	39,7	54,7	58,7	63,7	60,7	57,7	47,7	67,2
9	Inlet	25,7	35,7	47,7	53,7	53,7	53,7	50,7	41,7	59,6
	Outlet	25,7	37,7	51,7	56,7	63,7	60,7	55,7	46,7	66,6
10	Inlet	23,8	37,8	45,8	50,8	48,8	48,8	49,8	39,8	56,2
	Outlet	24,8	39,8	50,8	54,8	58,8	56,8	54,8	44,8	63,0
11	Inlet	21,8	32,8	42,8	47,8	47,8	47,8	46,8	37,8	54,1
	Outlet	21,8	33,8	48,8	52,8	57,8	54,8	51,8	41,8	61,2
12	Inlet	19,8	29,8	41,8	47,8	47,8	47,8	44,8	35,8	53,6
	Outlet	19,8	31,8	45,8	50,8	57,8	54,8	49,8	40,8	60,7

PERFORMANCE CURVES - ACOUSTIC CHARACTERISTICS

- q_v : Airflow in m^3/h .
- p_{sf} : Static pressure in Pa.
- P: Input power in W.
- SFP: Specific fan power in $W/m^3/s$ (blue curves).
- Performance data in accordance with ISO 5801 and AMCA 210-99 Standards.

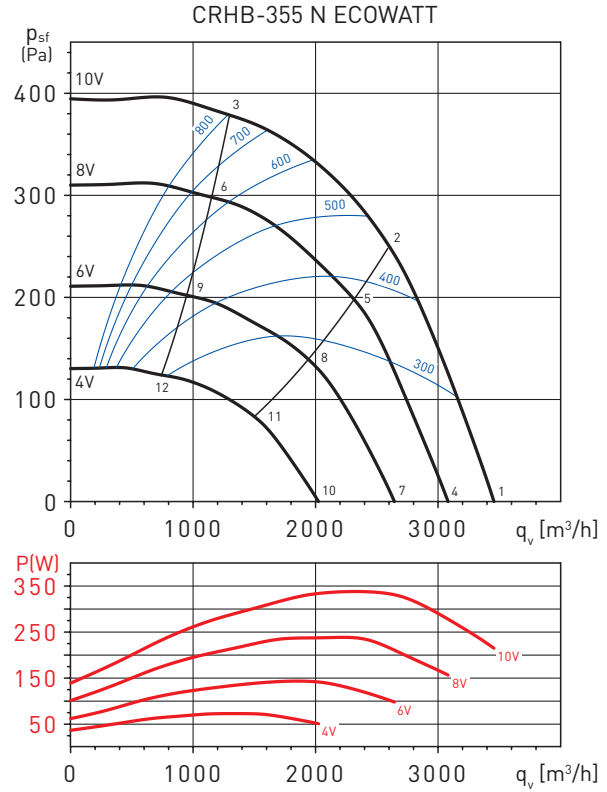
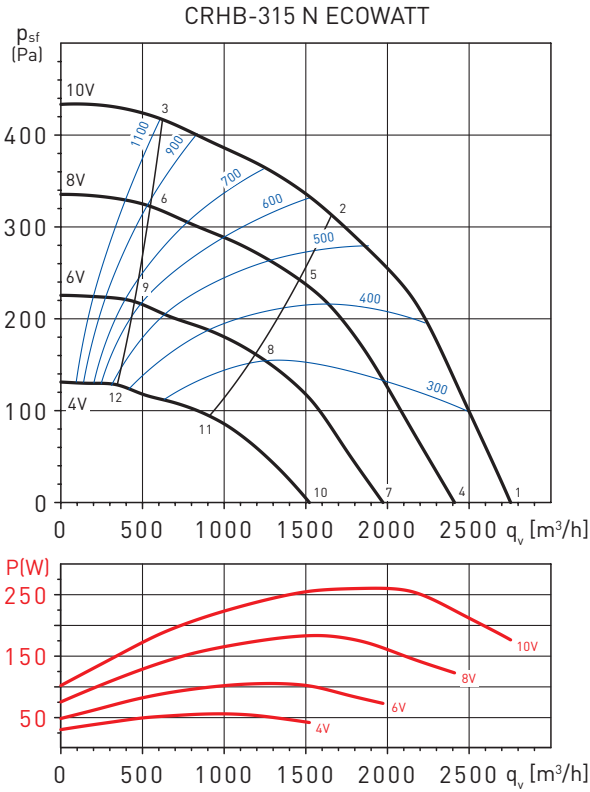

Working point	63	125	250	500	1.000	2.000	4.000	8.000	LwA
1	Inlet	39,0	53,0	64,0	65,0	65,0	66,0	56,0	72,2
	Outlet	41,0	56,0	68,0	72,0	74,0	70,0	59,0	78,4
2	Inlet	33,0	45,0	59,0	60,0	61,0	62,0	50,0	67,3
	Outlet	39,0	47,0	63,0	67,0	72,0	67,0	54,0	74,7
3	Inlet	51,0	59,0	63,0	62,0	63,0	63,0	52,0	69,8
	Outlet	52,0	61,0	66,0	69,0	73,0	70,0	66,0	76,8
4	Inlet	36,2	50,2	61,2	62,2	62,2	62,2	53,2	69,4
	Outlet	38,2	53,2	65,2	69,2	71,2	67,2	56,2	75,6
5	Inlet	30,2	42,2	56,2	57,2	58,2	59,2	47,2	64,5
	Outlet	36,2	44,2	60,2	64,2	69,2	64,2	51,2	72,0
6	Inlet	48,2	56,2	60,2	59,2	60,2	57,2	49,2	67,1
	Outlet	49,2	58,2	63,2	66,2	70,2	67,2	56,2	74,0
7	Inlet	28,6	42,6	53,6	54,6	54,6	55,6	45,6	61,8
	Outlet	33,4	48,4	60,4	64,4	66,4	62,4	51,4	70,7
8	Inlet	25,4	37,4	51,4	52,4	53,4	54,4	42,4	59,7
	Outlet	31,4	39,4	55,4	59,4	64,4	59,4	46,4	67,1
9	Inlet	43,4	51,4	55,4	54,4	55,4	52,4	44,4	62,2
	Outlet	44,4	53,4	58,4	61,4	65,4	62,4	51,4	69,2
10	Inlet	25,5	39,5	50,5	51,5	51,5	52,5	42,5	58,7
	Outlet	27,5	42,5	54,5	58,5	60,5	56,5	45,5	64,8
11	Inlet	19,5	31,5	45,5	46,5	47,5	44,5	36,5	53,8
	Outlet	25,5	33,5	49,5	53,5	58,5	53,5	40,5	61,2
12	Inlet	37,5	45,5	49,5	48,5	49,5	46,5	38,5	56,3
	Outlet	38,5	47,5	52,5	55,5	59,5	52,5	45,5	63,3

Working point	63	125	250	500	1.000	2.000	4.000	8.000	LwA
1	Inlet	40,0	57,0	65,0	65,0	65,0	65,0	56,0	72,2
	Outlet	41,0	63,0	67,0	72,0	76,0	73,0	71,0	79,9
2	Inlet	35,0	52,0	57,0	58,0	61,0	65,0	63,0	69,0
	Outlet	36,0	58,0	62,0	68,0	73,0	71,0	68,0	76,8
3	Inlet	42,0	55,0	60,0	60,0	63,0	63,0	59,0	68,6
	Outlet	42,0	58,0	61,0	68,0	74,0	72,0	68,0	77,5
4	Inlet	37,4	54,4	62,4	62,4	62,4	62,4	53,4	69,7
	Outlet	38,4	60,4	64,4	69,4	73,4	70,4	68,4	77,3
5	Inlet	32,4	49,4	54,4	55,4	58,4	62,4	60,4	66,5
	Outlet	33,4	55,4	59,4	65,4	70,4	68,4	65,4	74,3
6	Inlet	39,4	52,4	57,4	57,4	60,4	60,4	56,4	66,1
	Outlet	39,4	55,4	58,4	65,4	71,4	69,4	65,4	75,0
7	Inlet	30,7	47,7	55,7	55,7	55,7	55,7	46,7	62,9
	Outlet	34,2	56,2	60,2	65,2	69,2	66,2	64,2	73,1
8	Inlet	28,2	45,2	50,2	51,2	54,2	58,2	56,2	62,3
	Outlet	29,2	51,2	55,2	61,2	66,2	64,2	61,2	70,1
9	Inlet	35,2	48,2	53,2	53,2	56,2	56,2	52,2	61,9
	Outlet	35,2	51,2	54,2	61,2	67,2	65,2	61,2	70,8
10	Inlet	27,9	44,9	52,9	52,9	52,9	52,9	43,9	60,1
	Outlet	28,9	50,9	54,9	59,9	63,9	60,9	58,9	67,8
11	Inlet	22,9	39,9	44,9	45,9	48,9	52,9	50,9	57,0
	Outlet	23,9	45,9	49,9	55,9	60,9	58,9	55,9	64,8
12	Inlet	29,9	42,9	47,9	47,9	50,9	50,9	46,9	56,5
	Outlet	29,9	45,9	48,9	55,9	61,9	59,9	55,9	65,4

PERFORMANCE CURVES - ACOUSTIC CHARACTERISTICS

- q_v : Airflow in m^3/h .
- p_{sf} : Static pressure in Pa.
- P: Input power in W.
- SFP: Specific fan power in $W/m^3/s$ (blue curves).
- Performance data in accordance with ISO 5801 and AMCA 210-99 Standards.

CRHB-400 N ECOWATT

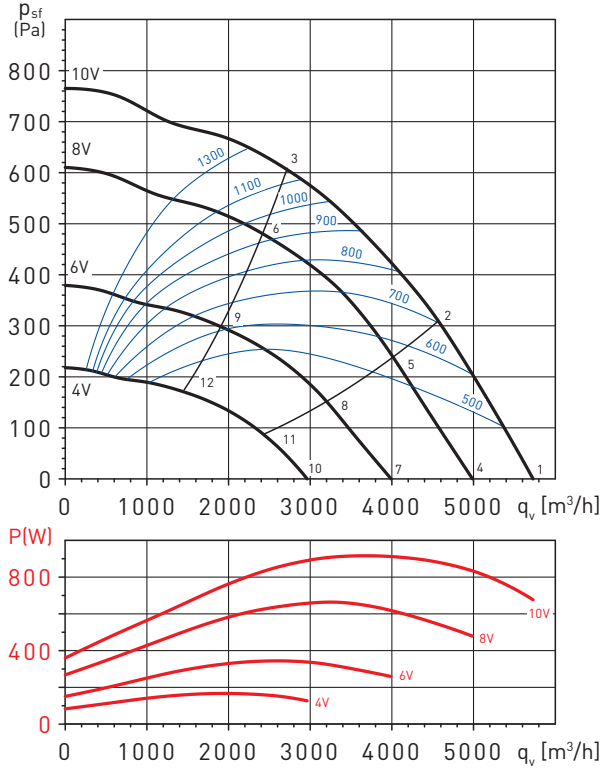

CRHB-450 N ECOWATT

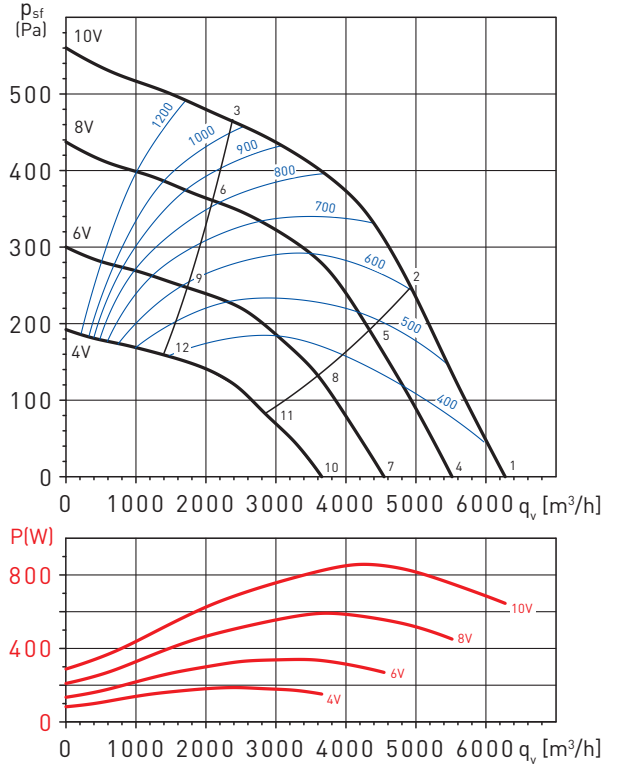

Working point		63	125	250	500	1.000	2.000	4.000	8.000	LwA
1	Inlet	44	59	74	78	76	74	76	65	83
	Outlet	47	63	80	83	85	81	80	70	89
2	Inlet	44	56	70	72	71	72	70	61	78
	Outlet	45	60	77	78	81	77	73	66	85
3	Inlet	42	53	64	67	66	68	63	57	73
	Outlet	44	57	71	74	76	75	71	65	81
4	Inlet	42	57	72	75	73	72	73	63	80
	Outlet	44	61	78	81	83	78	77	68	87
5	Inlet	42	53	68	70	69	70	67	58	76
	Outlet	43	57	74	76	78	75	71	64	83
6	Inlet	40	50	62	64	63	66	61	55	71
	Outlet	42	55	69	71	74	73	69	62	79
7	Inlet	37	52	67	70	68	67	68	57	75
	Outlet	39	56	73	75	78	73	72	62	82
8	Inlet	36	48	63	65	63	65	62	53	71
	Outlet	38	52	69	71	73	70	66	59	77
9	Inlet	34	45	57	59	58	61	56	50	66
	Outlet	36	50	64	66	69	67	63	57	73
10	Inlet	31	46	61	64	62	61	62	51	69
	Outlet	33	50	67	69	72	67	66	56	76
11	Inlet	30	42	57	59	57	59	56	47	65
	Outlet	32	46	63	65	67	64	60	53	71
12	Inlet	28	39	51	53	52	55	50	44	60
	Outlet	30	44	58	60	63	61	57	51	67

Working point		63	125	250	500	1.000	2.000	4.000	8.000	LwA
1	Inlet	43	61	68	73	72	73	72	63	79
	Outlet	45	69	74	80	82	80	79	71	87
2	Inlet	42	58	66	70	68	71	66	58	76
	Outlet	51	65	72	74	77	77	74	69	83
3	Inlet	50	62	69	71	67	69	64	58	76
	Outlet	42	66	70	76	77	76	72	66	82
4	Inlet	40	58	66	71	69	70	69	60	76
	Outlet	43	66	71	77	79	77	76	68	84
5	Inlet	39	55	63	67	65	68	63	55	73
	Outlet	48	62	69	71	75	75	71	66	80
6	Inlet	48	59	66	68	65	66	62	56	73
	Outlet	40	63	68	73	75	73	69	63	80
7	Inlet	36	54	62	67	65	66	65	56	72
	Outlet	39	62	67	73	75	73	72	64	80
8	Inlet	35	51	59	63	61	64	59	51	69
	Outlet	44	58	65	67	71	71	67	62	76
9	Inlet	43	55	62	64	61	62	57	52	69
	Outlet	36	59	64	69	71	69	65	59	75
10	Inlet	32	49	57	62	60	61	60	51	67
	Outlet	34	58	62	68	70	68	67	59	75
11	Inlet	30	47	54	58	56	60	54	46	64
	Outlet	39	54	60	62	66	66	62	57	71
12	Inlet	39	50	57	59	56	57	53	47	64
	Outlet	31	54	59	64	66	65	60	54	71

PERFORMANCE CURVES - ACOUSTIC CHARACTERISTICS

- q_v : Airflow in m^3/h .
- p_{sf} : Static pressure in Pa.
- P: Input power in W.
- SFP: Specific fan power in $W/m^3/s$ (blue curves).
- Performance data in accordance with ISO 5801 and AMCA 210-99 Standards.

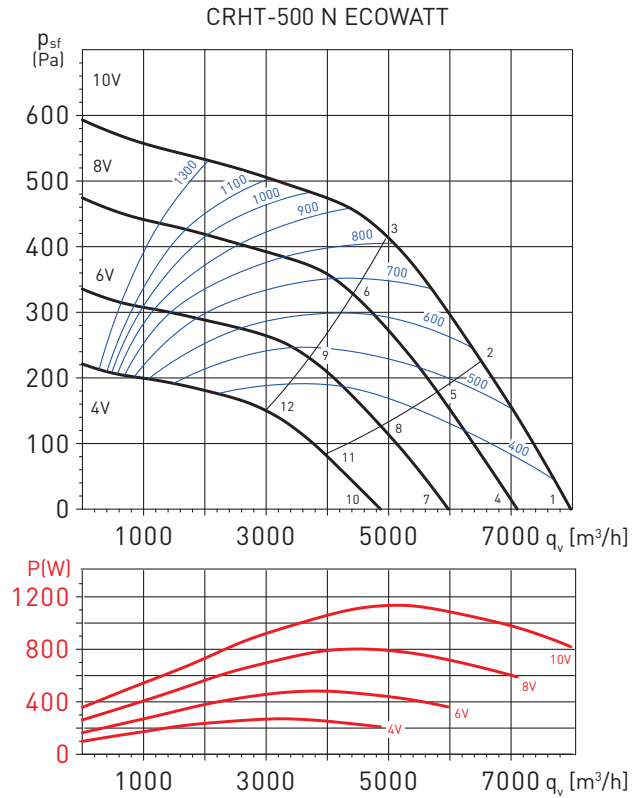
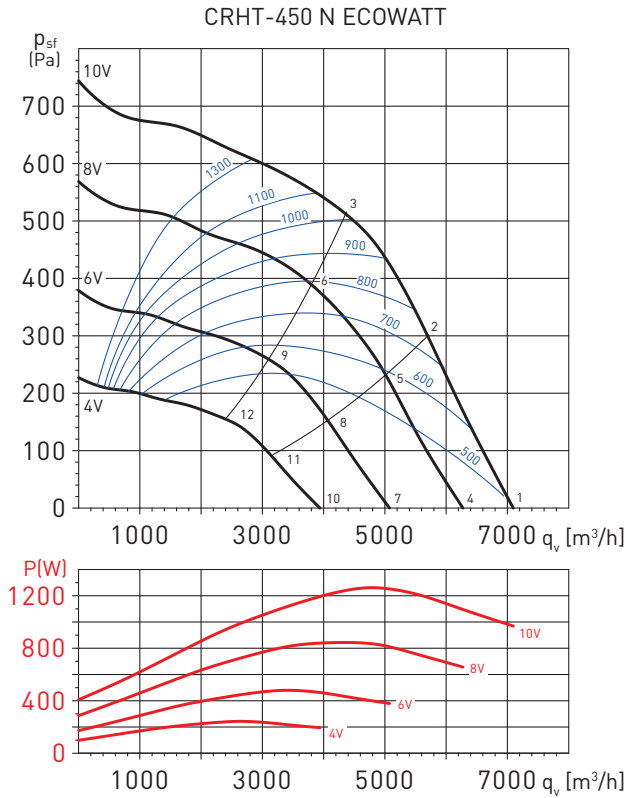

Working point		63	125	250	500	1.000	2.000	4.000	8.000	LwA
1	Inlet	45	60	74	77	76	75	74	67	82
	Outlet	49	66	81	85	87	83	81	75	91
2	Inlet	43	57	71	72	71	73	69	62	79
	Outlet	47	63	78	82	84	80	76	71	88
3	Inlet	42	56	68	69	70	72	68	61	77
	Outlet	46	61	75	78	81	79	75	70	85
4	Inlet	42	57	71	74	73	72	71	64	79
	Outlet	46	63	78	82	85	80	78	73	88
5	Inlet	40	54	68	70	69	70	67	59	76
	Outlet	44	60	75	79	81	77	74	68	85
6	Inlet	40	53	65	66	67	70	65	58	74
	Outlet	43	58	73	76	78	76	73	67	83
7	Inlet	38	52	67	69	69	68	66	60	75
	Outlet	42	59	74	78	80	76	73	68	84
8	Inlet	36	50	64	65	64	66	62	55	71
	Outlet	39	56	71	74	77	73	69	63	81
9	Inlet	35	48	61	62	62	65	61	54	70
	Outlet	39	54	68	71	74	72	68	62	78
10	Inlet	32	47	61	64	63	62	61	54	70
	Outlet	36	53	68	72	75	70	68	63	79
11	Inlet	30	44	58	60	59	60	57	49	66
	Outlet	34	50	65	69	71	67	64	58	75
12	Inlet	30	43	55	56	57	60	55	48	64
	Outlet	33	48	63	66	68	66	63	57	73

Working point		63	125	250	500	1.000	2.000	4.000	8.000	LwA
1	Inlet	46	65	73	72	72	73	70	66	79
	Outlet	48	71	76	80	81	79	77	70	86
2	Inlet	42	64	70	68	70	69	64	59	76
	Outlet	44	68	73	77	78	75	71	65	83
3	Inlet	41	61	69	66	68	68	64	59	75
	Outlet	43	67	71	75	77	75	70	64	81
4	Inlet	44	62	70	70	70	71	67	63	77
	Outlet	46	69	74	78	79	77	74	68	84
5	Inlet	39	61	67	65	67	66	62	57	73
	Outlet	42	66	71	75	76	73	69	63	80
6	Inlet	38	58	66	63	66	66	61	56	72
	Outlet	41	65	69	72	74	72	68	62	79
7	Inlet	40	59	66	66	66	67	63	60	73
	Outlet	42	65	70	74	75	73	70	64	80
8	Inlet	36	57	63	62	63	62	58	53	69
	Outlet	38	62	67	71	72	69	65	59	77
9	Inlet	35	54	62	59	62	62	57	52	68
	Outlet	37	61	65	68	70	68	64	58	75
10	Inlet	35	54	62	61	61	62	59	55	69
	Outlet	38	60	65	69	70	68	66	59	75
11	Inlet	31	53	59	57	59	58	53	49	65
	Outlet	33	57	62	66	67	64	60	54	72
12	Inlet	30	50	58	55	57	58	53	48	64
	Outlet	32	56	60	64	66	64	59	53	70

PERFORMANCE CURVES - ACOUSTIC CHARACTERISTICS

- q_v : Airflow in m^3/h .
- p_{sf} : Static pressure in Pa.
- P: Input power in W.
- SFP: Specific fan power in $W/m^3/s$ (blue curves).
- Performance data in accordance with ISO 5801 and AMCA 210-99 Standards.

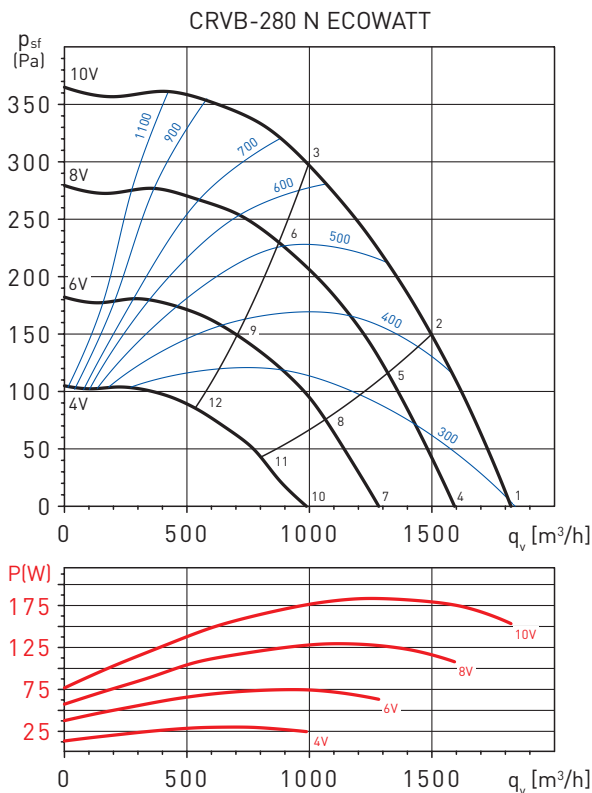
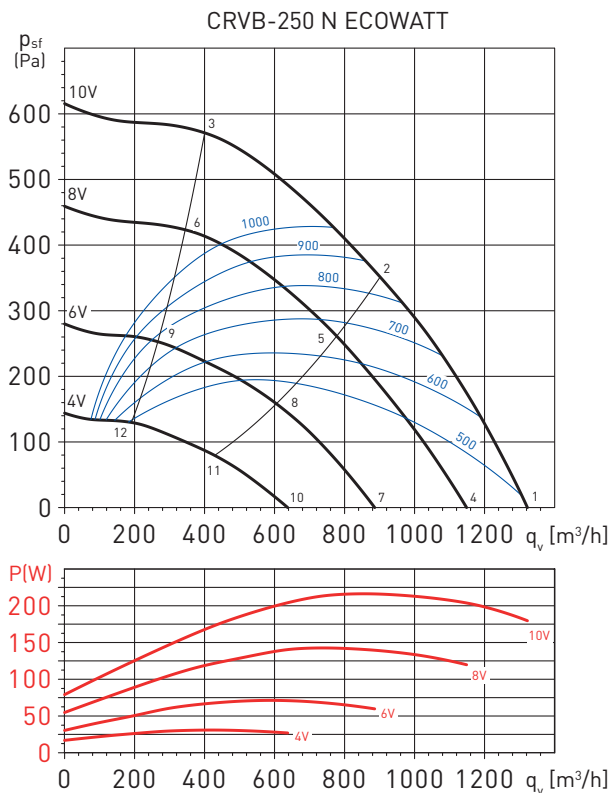

Working point		63	125	250	500	1.000	2.000	4.000	8.000	LwA
1	Inlet	36,0	49,0	63,0	66,0	69,0	68,0	69,0	62,0	75,0
	Outlet	43,0	51,0	65,0	69,0	73,0	75,0	72,0	65,0	79,0
2	Inlet	35,0	46,0	62,0	61,0	64,0	64,0	62,0	57,0	70,0
	Outlet	37,0	45,0	62,0	64,0	68,0	71,0	66,0	60,0	74,0
3	Inlet	35,0	49,0	61,0	64,0	65,0	69,0	64,0	59,0	73,0
	Outlet	35,0	48,0	61,0	66,0	70,0	75,0	71,0	64,0	78,0
4	Inlet	33,0	46,0	60,0	63,0	66,0	65,0	66,0	58,0	72,0
	Outlet	40,0	47,0	62,0	66,0	69,0	72,0	69,0	62,0	76,0
5	Inlet	32,0	43,0	58,0	58,0	60,0	61,0	59,0	54,0	67,0
	Outlet	34,0	42,0	59,0	60,0	65,0	68,0	63,0	56,0	71,0
6	Inlet	32,0	46,0	58,0	61,0	62,0	66,0	61,0	56,0	70,0
	Outlet	32,0	45,0	58,0	63,0	67,0	72,0	68,0	61,0	75,0
7	Inlet	27,0	40,0	55,0	57,0	61,0	60,0	60,0	53,0	66,0
	Outlet	34,0	42,0	56,0	60,0	64,0	66,0	63,0	56,0	70,0
8	Inlet	27,0	37,0	53,0	53,0	55,0	55,0	54,0	48,0	61,0
	Outlet	28,0	37,0	53,0	55,0	59,0	62,0	57,0	51,0	66,0
9	Inlet	27,0	40,0	53,0	55,0	57,0	61,0	56,0	50,0	64,0
	Outlet	27,0	39,0	53,0	58,0	61,0	66,0	62,0	55,0	69,0
10	Inlet	20,0	33,0	47,0	50,0	53,0	52,0	53,0	46,0	59,0
	Outlet	27,0	35,0	49,0	53,0	57,0	59,0	56,0	49,0	63,0
11	Inlet	19,0	30,0	46,0	45,0	48,0	48,0	46,0	41,0	54,0
	Outlet	21,0	29,0	46,0	48,0	52,0	55,0	50,0	44,0	58,0
12	Inlet	19,0	33,0	45,0	48,0	49,0	53,0	48,0	43,0	57,0
	Outlet	19,0	32,0	45,0	50,0	54,0	59,0	55,0	48,0	62,0

Working point		63	125	250	500	1.000	2.000	4.000	8.000	LwA
1	Inlet	37,0	48,0	60,0	64,0	63,0	64,0	61,0	53,0	69,8
	Outlet	41,0	51,0	71,0	71,0	75,0	72,0	65,0	55,0	78,8
2	Inlet	34,0	44,0	58,0	63,0	62,0	63,0	59,0	51,0	68,5
	Outlet	37,0	46,0	68,0	72,0	74,0	71,0	62,0	52,0	77,9
3	Inlet	33,0	43,0	55,0	61,0	61,0	61,0	58,0	49,0	66,8
	Outlet	33,0	45,0	59,0	64,0	71,0	68,0	63,0	54,0	73,9
4	Inlet	34,1	45,1	57,1	61,1	60,1	61,1	58,1	50,1	66,9
	Outlet	38,1	48,1	68,1	68,1	72,1	69,1	62,1	52,1	75,9
5	Inlet	31,1	41,1	55,1	60,1	59,1	60,1	56,1	48,1	65,7
	Outlet	34,1	43,1	65,1	69,1	71,1	68,1	59,1	49,1	75,0
6	Inlet	30,1	40,1	55,1	59,1	59,1	60,1	54,1	47,1	65,2
	Outlet	33,1	43,1	59,1	68,1	70,1	66,1	58,1	49,1	73,5
7	Inlet	26,6	37,6	49,6	53,6	52,6	53,6	50,6	42,6	59,4
	Outlet	33,5	43,5	63,5	63,5	67,5	64,5	57,5	47,5	71,3
8	Inlet	26,5	36,5	50,5	55,5	54,5	55,5	51,5	43,5	61,0
	Outlet	29,5	38,5	60,5	64,5	66,5	63,5	54,5	44,5	70,4
9	Inlet	25,5	35,5	50,5	54,5	54,5	55,5	49,5	42,5	60,6
	Outlet	28,5	38,5	54,5	63,5	65,5	61,5	53,5	44,5	68,9
10	Inlet	23,5	34,5	46,5	50,5	49,5	50,5	47,5	39,5	56,3
	Outlet	27,5	37,5	57,5	57,5	61,5	58,5	51,5	41,5	65,3
11	Inlet	20,5	30,5	44,5	49,5	48,5	49,5	45,5	37,5	55,1
	Outlet	23,5	32,5	54,5	58,5	60,5	57,5	48,5	38,5	64,4
12	Inlet	19,5	29,5	44,5	48,5	48,5	49,5	43,5	36,5	54,6
	Outlet	22,5	32,5	48,5	57,5	59,5	55,5	47,5	38,5	62,9

PERFORMANCE CURVES - ACOUSTIC CHARACTERISTICS

- q_v : Airflow in m^3/h .
- p_{sf} : Static pressure in Pa.
- P: Input power in W.
- SFP: Specific fan power in $W/m^3/s$ (blue curves).
- Performance data in accordance with ISO 5801 and AMCA 210-99 Standards.

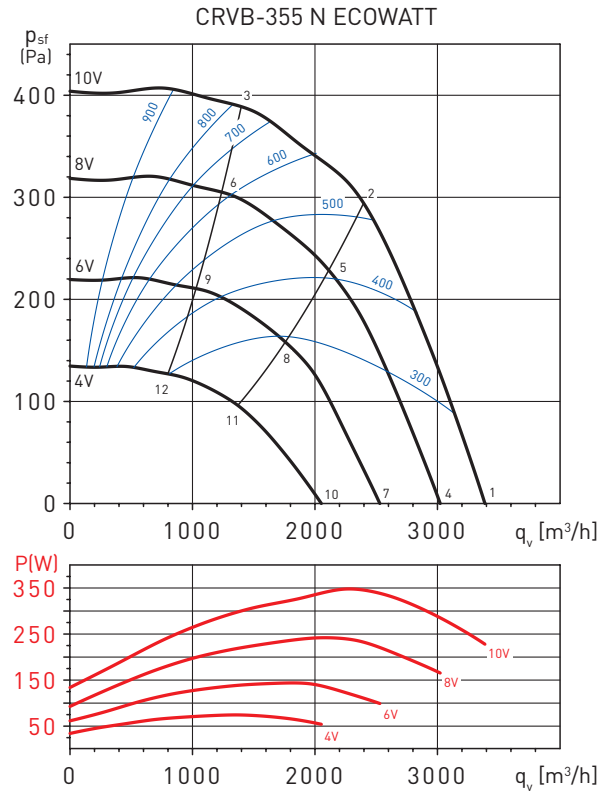
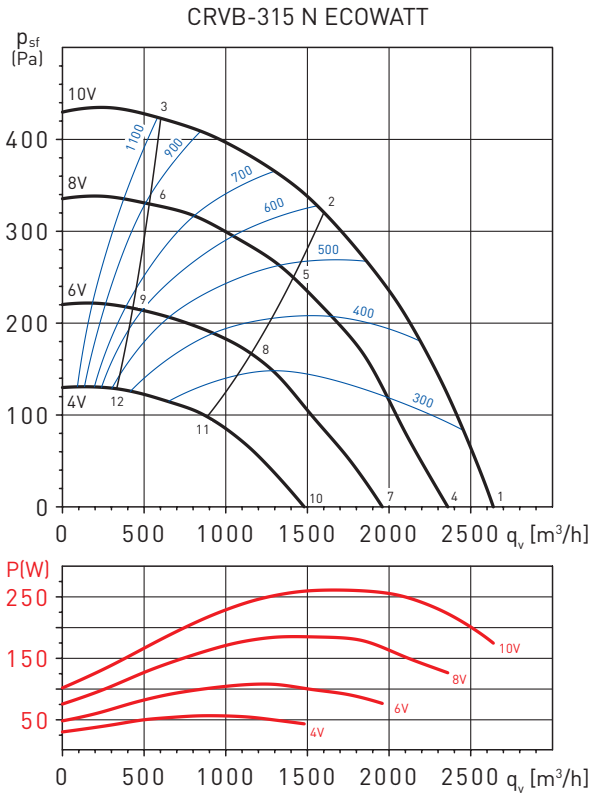

Working point		63	125	250	500	1000	2000	4000	8000	LwA
1	Inlet	41,0	55,0	74,0	68,0	67,0	65,0	65,0	57,0	76,4
	Outlet	41,0	53,0	65,0	59,0	67,0	66,0	64,0	57,0	72,1
2	Inlet	39,0	51,0	73,0	68,0	65,0	64,0	61,0	53,0	75,3
	Outlet	39,0	51,0	63,0	58,0	65,0	65,0	60,0	53,0	70,1
3	Inlet	37,0	49,0	68,0	68,0	65,0	62,0	59,0	53,0	72,7
	Outlet	36,0	47,0	58,0	56,0	65,0	64,0	60,0	53,0	69,0
4	Inlet	38,2	52,2	71,2	65,2	64,2	62,2	62,2	54,2	73,6
	Outlet	38,2	50,2	62,2	56,2	64,2	63,2	61,2	54,2	69,3
5	Inlet	36,2	48,2	70,2	65,2	62,2	61,2	58,2	50,2	72,5
	Outlet	36,2	48,2	60,2	55,2	62,2	62,2	57,2	50,2	67,3
6	Inlet	34,2	46,2	65,2	65,2	62,2	59,2	56,2	50,2	69,9
	Outlet	33,2	44,2	55,2	53,2	62,2	61,2	57,2	50,2	66,2
7	Inlet	30,6	44,6	63,6	57,6	56,6	54,6	54,6	46,6	66,0
	Outlet	33,4	45,4	57,4	51,4	59,4	58,4	56,4	49,4	64,5
8	Inlet	31,4	43,4	65,4	60,4	57,4	56,4	53,4	45,4	67,6
	Outlet	31,4	43,4	55,4	50,4	57,4	57,4	52,4	45,4	62,5
9	Inlet	29,4	41,4	60,4	60,4	57,4	54,4	51,4	45,4	65,0
	Outlet	28,4	39,4	50,4	48,4	57,4	56,4	52,4	45,4	61,4
10	Inlet	27,5	41,5	60,5	54,5	53,5	51,5	51,5	43,5	62,9
	Outlet	27,5	39,5	51,5	45,5	53,5	52,5	50,5	43,5	58,6
11	Inlet	25,5	37,5	59,5	54,5	51,5	50,5	47,5	39,5	61,7
	Outlet	25,5	37,5	49,5	44,5	51,5	51,5	46,5	39,5	56,6
12	Inlet	23,5	35,5	54,5	54,5	51,5	48,5	45,5	39,5	59,1
	Outlet	22,5	33,5	44,5	42,5	51,5	50,5	46,5	39,5	55,5

Working point		63	125	250	500	1000	2000	4000	8000	LwA
1	Inlet	37,0	50,0	59,0	61,0	62,0	64,0	62,0	50,0	69,0
	Outlet	37,0	58,0	65,0	68,0	69,0	67,0	65,0	53,0	74,2
2	Inlet	31,0	45,0	56,0	60,0	60,0	61,0	55,0	46,0	66,1
	Outlet	32,0	57,0	63,0	67,0	67,0	65,0	58,0	49,0	72,1
3	Inlet	44,0	53,0	61,0	62,0	62,0	59,0	53,0	46,0	67,5
	Outlet	44,0	55,0	62,0	68,0	69,0	66,0	59,0	51,0	73,2
4	Inlet	34,3	47,3	56,3	58,3	59,3	61,3	59,3	47,3	66,3
	Outlet	34,3	55,3	62,3	65,3	66,3	64,3	62,3	50,3	71,5
5	Inlet	28,3	42,3	53,3	57,3	57,3	58,3	52,3	43,3	63,3
	Outlet	29,3	54,3	60,3	64,3	64,3	62,3	55,3	46,3	69,4
6	Inlet	41,3	50,3	58,3	59,3	59,3	56,3	50,3	43,3	64,8
	Outlet	41,3	52,3	59,3	65,3	66,3	63,3	56,3	48,3	70,5
7	Inlet	27,6	40,6	49,6	51,6	52,6	54,6	52,6	40,6	59,6
	Outlet	30,4	51,4	58,4	61,4	62,4	60,4	58,4	46,4	67,6
8	Inlet	24,4	38,4	49,4	53,4	53,4	54,4	48,4	39,4	59,4
	Outlet	25,4	50,4	56,4	60,4	60,4	58,4	51,4	42,4	65,5
9	Inlet	37,4	46,4	54,4	55,4	55,4	52,4	46,4	39,4	60,9
	Outlet	37,4	48,4	55,4	61,4	62,4	59,4	52,4	44,4	66,6
10	Inlet	25,0	38,0	47,0	49,0	50,0	52,0	50,0	38,0	57,0
	Outlet	25,0	46,0	53,0	56,0	57,0	55,0	53,0	41,0	62,2
11	Inlet	19,0	33,0	44,0	48,0	48,0	49,0	43,0	34,0	54,1
	Outlet	20,0	45,0	51,0	55,0	55,0	53,0	46,0	37,0	60,1
12	Inlet	32,0	41,0	49,0	50,0	50,0	47,0	41,0	34,0	55,5
	Outlet	32,0	43,0	50,0	56,0	57,0	54,0	47,0	39,0	61,2



PERFORMANCE CURVES - ACOUSTIC CHARACTERISTICS

- q_v : Airflow in m^3/h .
- p_{sf} : Static pressure in Pa.
- P: Input power in W.
- SFP: Specific fan power in $W/m^3/s$ (blue curves).
- Performance data in accordance with ISO 5801 and AMCA 210-99 Standards.

CRVB-400 N ECOWATT

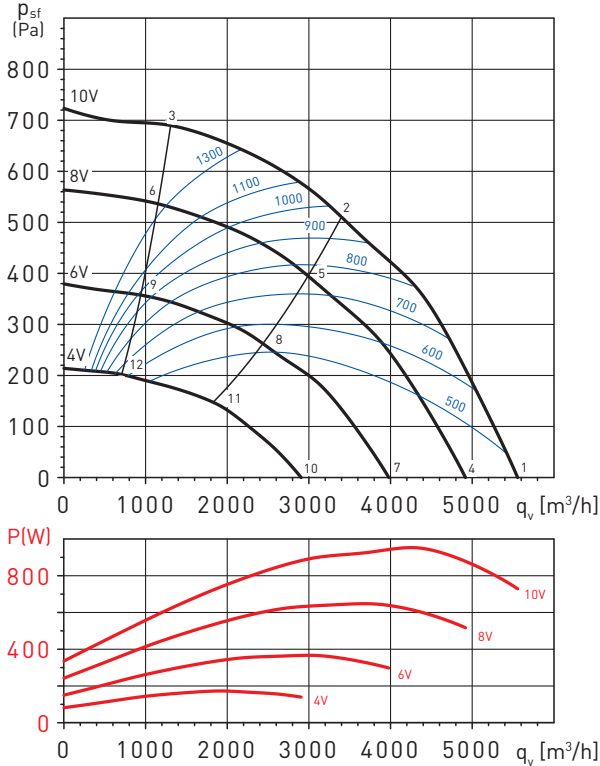

CRVB-450 N ECOWATT

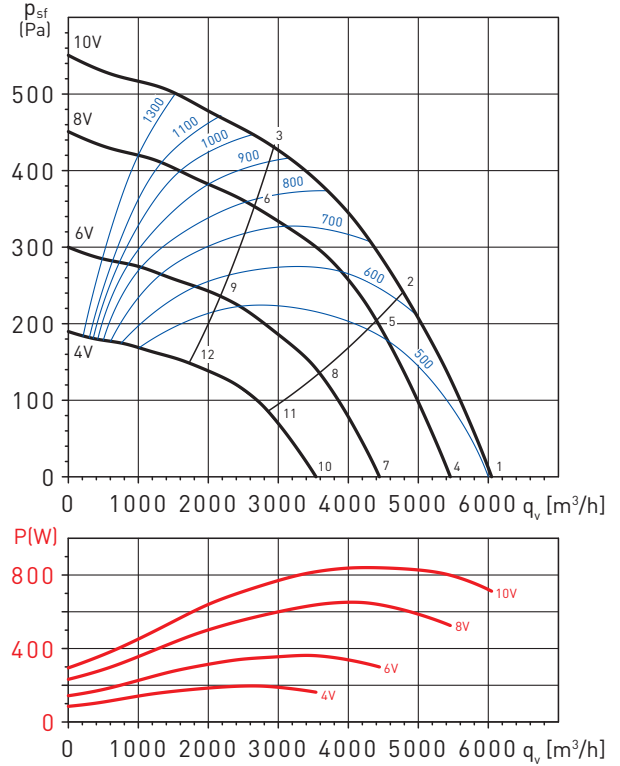

Working point		63	125	250	500	1000	2000	4000	8000	LwA
1	Inlet	44	60	71	73	76	77	74	63	82
	Outlet	52	61	76	80	82	80	77	68	87
2	Inlet	51	61	70	69	72	73	66	60	78
	Outlet	41	55	69	73	75	77	70	64	81
3	Inlet	55	66	73	71	72	73	68	63	79
	Outlet	55	67	74	76	78	78	72	67	83
4	Inlet	41	57	69	71	73	74	71	60	79
	Outlet	49	58	73	78	79	77	74	65	84
5	Inlet	49	58	67	66	69	70	64	57	75
	Outlet	38	52	66	71	73	74	67	61	78
6	Inlet	52	63	70	68	69	70	65	60	76
	Outlet	53	64	71	73	75	75	69	64	81
7	Inlet	37	52	64	66	68	69	67	56	74
	Outlet	44	54	69	73	75	72	70	61	79
8	Inlet	44	54	63	62	64	66	59	53	71
	Outlet	34	48	62	66	68	70	63	57	74
9	Inlet	48	59	65	63	65	66	60	56	72
	Outlet	48	60	67	69	71	71	65	59	76
10	Inlet	31	46	58	60	62	63	60	50	68
	Outlet	38	48	63	67	69	66	63	54	73
11	Inlet	38	48	57	56	58	60	53	47	64
	Outlet	28	41	56	60	62	64	57	51	68
12	Inlet	42	53	59	57	58	59	54	50	65
	Outlet	42	53	60	63	65	65	59	53	70

Working point		63	125	250	500	1000	2000	4000	8000	LwA
1	Inlet	42	61	67	73	72	73	71	65	79
	Outlet	49	66	72	77	81	78	75	68	85
2	Inlet	35	46	62	61	64	64	62	57	70
	Outlet	41	65	70	74	78	76	71	65	82
3	Inlet	35	49	61	64	65	69	64	59	73
	Outlet	43	61	67	71	76	75	71	66	80
4	Inlet	40	58	65	71	70	71	68	62	77
	Outlet	47	63	70	75	78	76	72	66	82
5	Inlet	33	43	59	59	61	62	60	54	68
	Outlet	39	63	67	72	76	73	69	63	80
6	Inlet	33	47	59	62	63	67	62	57	71
	Outlet	41	58	65	68	74	73	69	64	78
7	Inlet	35	54	61	66	65	67	64	58	72
	Outlet	43	59	66	70	74	71	68	62	78
8	Inlet	29	39	55	55	57	57	56	50	63
	Outlet	34	58	63	67	71	69	65	58	75
9	Inlet	29	42	55	57	59	63	58	52	66
	Outlet	37	54	60	64	70	69	65	59	74
10	Inlet	31	49	56	62	60	62	59	53	67
	Outlet	38	54	61	66	69	66	63	57	73
11	Inlet	24	34	50	50	52	52	51	45	58
	Outlet	29	53	58	62	66	64	60	53	70
12	Inlet	24	37	50	53	54	58	53	47	61
	Outlet	32	49	55	59	65	64	60	54	69

PERFORMANCE CURVES - ACOUSTIC CHARACTERISTICS

- q_v : Airflow in m^3/h .
- p_{sf} : Static pressure in Pa.
- P: Input power in W.
- SFP: Specific fan power in $W/m^3/s$ (blue curves).
- Performance data in accordance with ISO 5801 and AMCA 210-99 Standards.

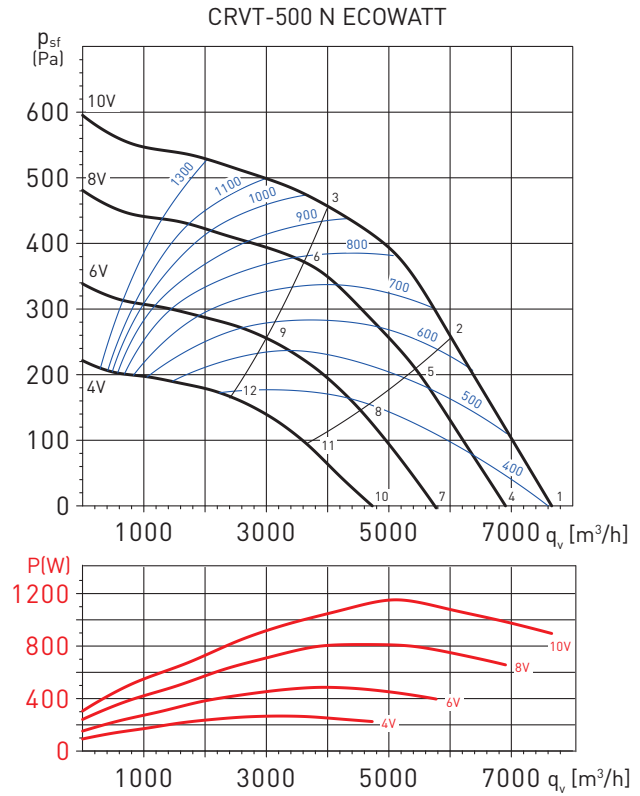
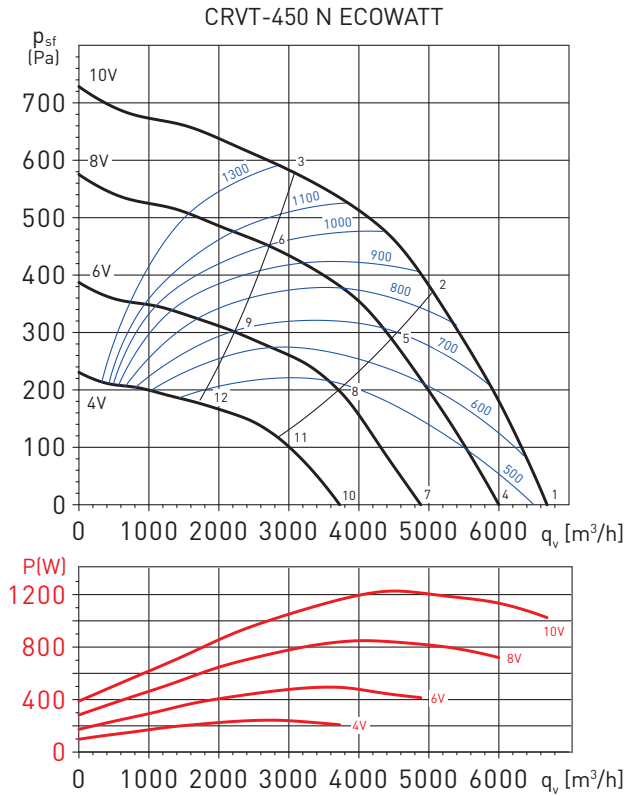

Working point		63	125	250	500	1000	2000	4000	8000	LwA
1	Inlet	45	59	72	77	74	75	74	69	82
	Outlet	52	63	77	81	84	80	79	73	88
2	Inlet	42	55	70	71	71	73	70	68	79
	Outlet	44	59	74	75	80	77	75	69	84
3	Inlet	45	58	73	71	71	73	70	67	79
	Outlet	47	58	71	73	79	79	76	71	84
4	Inlet	42	56	70	74	71	72	71	66	79
	Outlet	49	61	74	78	81	78	76	70	85
5	Inlet	39	53	67	68	68	71	68	65	76
	Outlet	41	56	71	73	77	75	72	67	81
6	Inlet	43	55	70	69	68	71	68	64	76
	Outlet	44	55	68	70	76	77	73	68	81
7	Inlet	38	52	65	69	67	68	67	61	75
	Outlet	45	56	70	73	77	73	72	66	81
8	Inlet	35	48	63	64	64	66	63	60	71
	Outlet	37	52	67	68	72	70	68	62	77
9	Inlet	38	51	66	64	63	66	63	59	72
	Outlet	40	51	64	66	72	72	69	64	77
10	Inlet	32	46	60	64	61	62	61	56	69
	Outlet	39	51	64	68	71	68	66	60	75
11	Inlet	29	43	57	58	58	61	58	55	66
	Outlet	31	46	61	63	67	65	62	57	71
12	Inlet	33	45	60	59	58	61	58	54	66
	Outlet	34	45	58	60	66	67	63	58	71

Working point		63	125	250	500	1000	2000	4000	8000	LwA
1	Inlet	42	63	69	70	70	71	68	64	77
	Outlet	55	70	74	77	79	77	73	68	84
2	Inlet	39	62	67	68	69	69	66	61	75
	Outlet	44	67	71	74	76	74	70	64	81
3	Inlet	41	59	66	66	68	69	66	61	74
	Outlet	42	63	68	72	75	74	70	65	80
4	Inlet	40	60	66	68	68	68	65	62	75
	Outlet	53	68	71	75	77	75	70	66	81
5	Inlet	36	60	65	66	67	67	64	59	73
	Outlet	42	65	68	72	74	72	68	62	79
6	Inlet	38	57	63	64	66	66	64	58	72
	Outlet	40	61	66	69	73	72	68	63	78
7	Inlet	36	57	63	64	64	65	61	58	71
	Outlet	49	64	68	71	73	71	67	62	78
8	Inlet	32	56	61	62	63	63	60	55	69
	Outlet	38	61	64	68	70	68	64	58	75
9	Inlet	34	53	59	60	62	63	60	54	68
	Outlet	36	57	62	65	69	68	64	59	74
10	Inlet	31	52	58	59	60	60	57	53	66
	Outlet	44	59	63	66	68	66	62	57	73
11	Inlet	28	51	56	57	58	58	55	50	65
	Outlet	34	56	60	63	66	63	59	53	70
12	Inlet	30	48	55	56	57	58	55	50	64
	Outlet	32	52	57	61	64	64	59	54	69

DIMENSIONS (mm) CRHB-N / CRHT-N ECOWATT

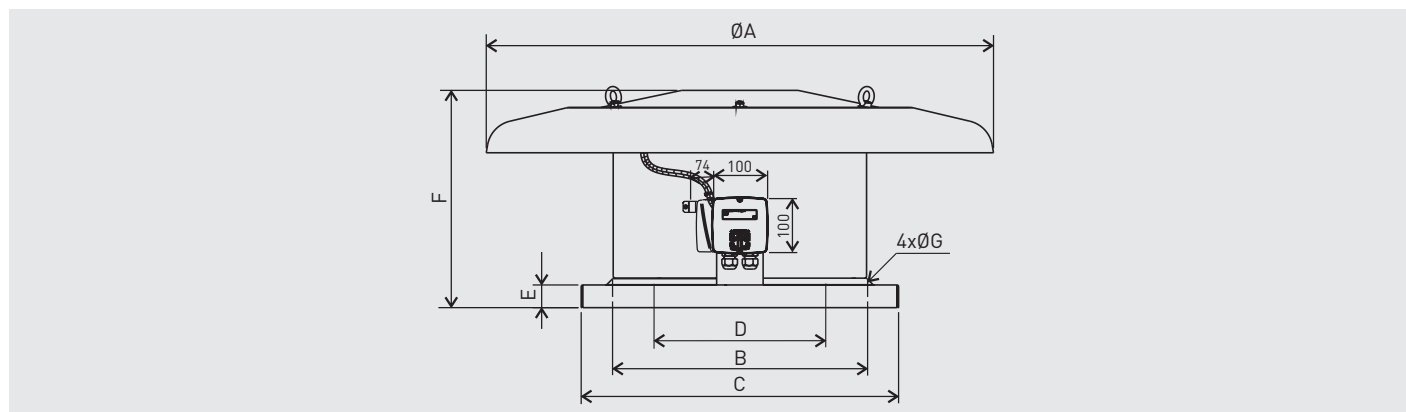

Model	ØA	∅B	∅C	ØD	E	F	G	H	I	J
250	570	245	326	204	35	228	10	100	100	74
280	640	330	435	228	40	273,5	12	100	100	74
315	895	450	560	257	40	324	12	100	100	74
355	895	450	560	289	40	367	12	100	100	74
400	1150	535	630	326	40	363	12	100	100	74
450	1150	535	630	367	40	397	12	100	100	74
500	1150	590	710	407	40	424	14	100	100	74

DIMENSIONS (mm) CRVB-N / CRVT-N ECOWATT

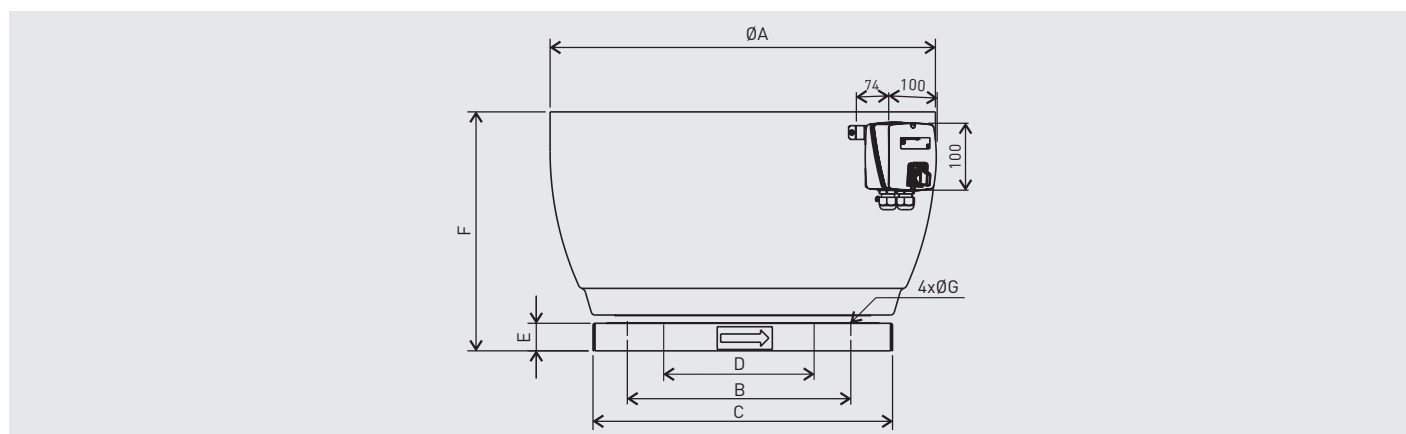

Model	ØA	∅B	∅C	ØD	E	F	G	H	I	J
250	434	245	326	204	35	260	10	100	100	74
280	560	330	435	228	40	305	12	100	100	74
315	754	450	560	257	40	395	12	100	100	74
355	754	450	560	289	40	395	12	100	100	74
400	857	535	630	326	40	459	12	100	100	74
450	857	535	630	367	40	459	12	100	100	74
500	950	590	710	407	40	530	14	100	100	74

INSTALLATION CRHB-N / CRHT-N / CRVB-N / CRVT-N ECOWATT - MOUNTING ACCESSORIES

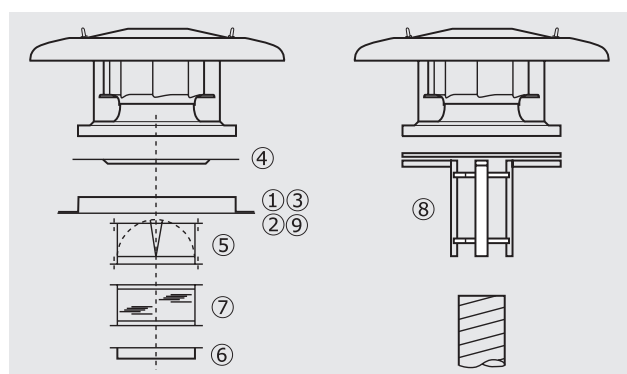

Model of fan	① Sealing frame	② Flat roof insulated up stand	③ Acoustic up stand	④ Accessory adapter plate	⑤ Back draft shutter	⑥ Flange with spigot	⑦ Flexible coupling	⑧ Circular adapter	⑨ Support base for inclined curb installations
250N	JMS-300	JBS-300	JAA-300	JPA-300	JCA-300	JBR-300 N	JAE-300 N	JCC-300	BI-3
280N	JMS-435	JBS-435	JAA-435	JPA-435	JCA-435	JBR-435	JAE-435	JCC-435	BI-4
315N	JMS-560	JBS-560	JAA-560	JPA-560	JCA-560	JBR-560	JAE-560	JCC-560	BI-5
355N	JMS-560	JBS-560	JAA-560	JPA-560	JCA-560	JBR-560	JAE-560	JCC-560	BI-5
400N	JMS-630	JBS-630	JAA-630	JPA-630	JCA-630	JBR-630	JAE-630	JCC-630	BI-6
450N	JMS-630	JBS-630	JAA-630	JPA-630	JCA-630	JBR-630	JAE-630	JCC-630	BI-6
500N	JMS-710	JBS-710	JAA-710	JPA-710	JCA-710	JBR-710	JAE-710	-	BI-7

MOUNTING ACCESSORIES

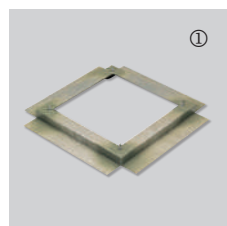

JMS
Sealing frame
- For mounting a roof fan on an up stand or base.
- Supplied with screws and gasket for a complete weatherproof seal.

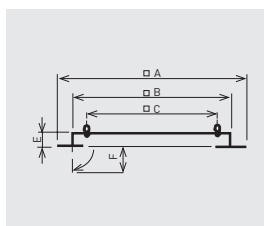

Model	□A	□B	□C	E	F
JMS-300	470	290	245	50	70
JMS-435	600	420	330	50	70
JMS-560	725	545	450	50	70
JMS-630	795	615	535	50	70
JMS-710	875	695	590	50	70



JBS
Flat roof up stand
- For mounting a fan on a flat roof without up stands.
- For use on horizontal roofs.
- Internal insulation to prevent condensation.
- Supplied with screws and gasket for a complete weather seal.

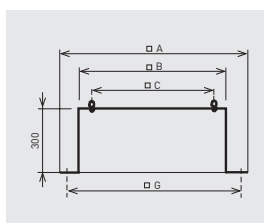

Model	□A	□B	□C	E	□G
JBS-300	470	289	245	300	380
JBS-435	600	419	330	300	510
JBS-560	725	544	450	300	635
JBS-630	795	614	535	300	705
JBS-710	875	694	590	300	785



JPA
Accessory adapter plate
- Used when mounting the accessories (JCA, JBR, JAE).
- Allows the fan to be disconnected from the upstand without having to remove the duct.

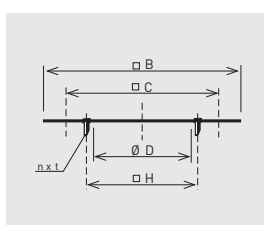

Model	□B	□C	∅ D	n x l	∅ H
JPA-300	289	245	182	4xM6	205
JPA-435	419	330	252	4xM8	280
JPA-560	544	450	358	8xM8	395
JPA-630	614	535	403	8xM10	450
JPA-710	694	590	503	12xM10	560



JCA / JCA N
Backdraft shutter
- Prevents backdraft when the fan is not operating.
- To be mounted at the fan inlet with the JPA plate.

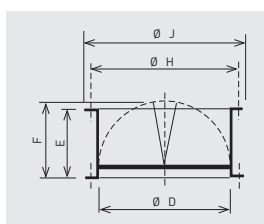

Model	∅ D	E	F	∅ H	∅ J
JCA-300	182	100	124	205	219
JCA-435	252	145	174	280	300
JCA-560 N	358	210	227	395	415
JCA-630 N	403	240	250	450	474
JCA-710 N	503	285	300	560	581



JBR N
Flange
- For use when circular connection is required directly to the fan.
- To be mounted at the fan inlet with the JPA plate or fixed directly to the fan base (rivets or screws not supplied).

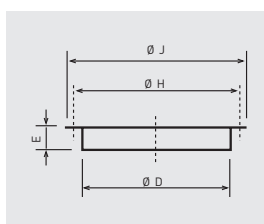

Model	∅ D	E	∅ H	∅ J
JBR-300 N	182	55	205	219
JBR-435 N	252	55	280	300
JBR-560 N	358	55	395	415
JBR-630 N	403	63	450	474
JBR-710 N	503	69	560	581



JAE N
Flexible coupling
- Reduces the transmission of vibrations when the duct is connected directly to the fan.
- To be mounted at the fan inlet with JPA plate.

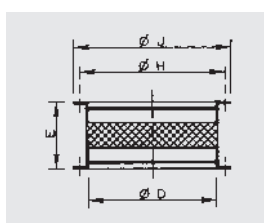

Model	∅ D	E	∅ H	∅ J
JAE-300 N	182	164	205	219
JAE-435 N	252	164	280	300
JAE-560 N	358	164	395	415
JAE-630 N	403	164	450	474
JAE-710 N	503	164	560	581



JCC
Adapter for circular duct
- For use when fitting the models up to 400, directly to a spirally wound circular duct.

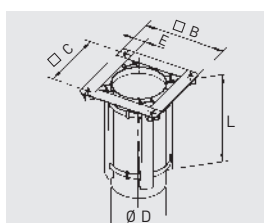

Model	∅ B	∅ C	∅ D	E	L
JCC-300	290	245	180	45	350
JCC-435	390	330	250	60	350
JCC-560	520	450	355	70	350
JCC-630	605	535	400	70	350

MOUNTING ACCESSORIES



BI
Support base for inclined curb mounted installations
 - To ensure a proper installation of the CRHB-CRHT roof fan it is essential to specify the roof pitch angle and the distance between the roof beam profiles.

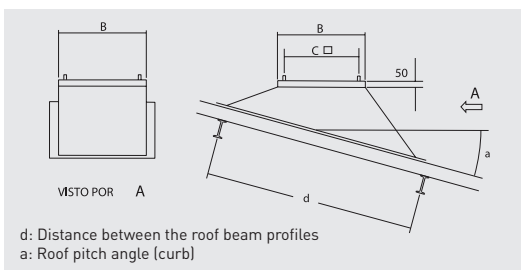

	B	C
BI-3	289	245
BI-4	419	330
BI-5	544	450
BI-6	614	535
BI-7	694	590



JAA
Acoustic up stand
 - Reduces in duct and radiated noise.
 - For use when mounting a fan on a flat roof without up stands.
 - Supplied with screws and gasket for a complete weather seal.

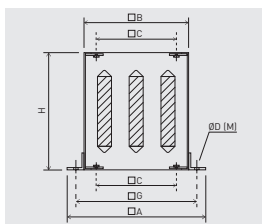

Model	□A	□B	□C	Ø D (M)	H	□G
JAA-300	470	290	245	13 (M10)	750	380
JAA-435	600	419	330	15 (M12)	750	510
JAA-560	725	545	450	15 (M12)	750	635
JAA-630	795	615	535	15 (M12)	750	705
JAA-710	875	695	590	18 (M12)	1000	785

Acoustic attenuation in dB(A) at the corresponding frequency band in Hz.

Model	125	250	500	1000	2000	4000	8000
JAA-300	1	5	13	22	23	16	12
JAA-435	1	7	16	23	25	18	13
JAA-560	2	8	16	29	32	26	17
JAA-630	2	8	14	24	27	19	13
JAA-710	2	8	14	24	28	16	11

JAA Attenuator pressure drops

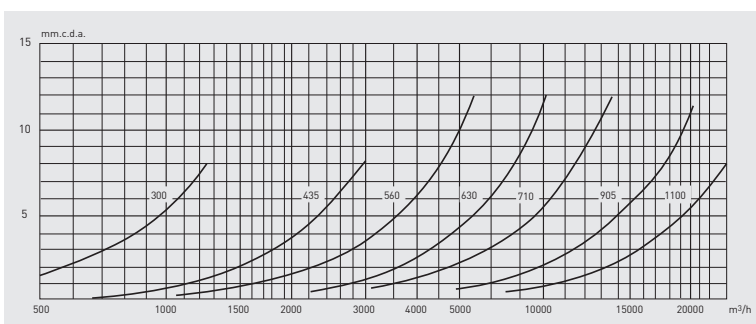

ELECTRICAL ACESORIES



AIRSENS-CO2
AIRSENS-VOC
AIRSENS-RH
 IAQ intelligent sensor that incorporates an internal CO₂ or VOC or HR sensor



CONTROL ECOWATT AC/4A
 Control element for demand controlled ventilation systems.



REB-ECOWATT
 Speed controller for fans fitted with EC motor.



TDP-S
 Pressure sensor without display.
TDP-D
 Pressure sensor with display.
TDP-PI
 Pressure sensor with display.



CPFL-S / CPFL-E
 Presence detector.



CONTROL ECOWATT BASIC
 Speed control and single-phase ON/OFF.